



# D-BOX G5

## Quick Start Guide

### PACKAGE CONTENTS

-  > 1x Haptic Bridge
  -  > 1x USB A to USB B Cable
  -  > 1x Power Supply
  -  > Mounting Screws (4 per actuator)
  -  > 1 to 4 Haptic Actuator(s)
  -  > 1 to 5 IEC Plug-Lock Insert(s)
  -  > Power Cables & "Y" Splitters
- |              |                                    |
|--------------|------------------------------------|
| <b>1250i</b> | 2x Power Cables                    |
| <b>2250i</b> | 2x Power Cables + 1x "Y" Splitters |
| <b>3250i</b> | 3x Power Cables + 1x "Y" Splitters |
| <b>4250i</b> | 3x Power Cables + 2x "Y" Splitters |

### OPTIONAL COMPONENTS (SELECTED AT ORDER)

-  > Endings (captive or non captive)
-  > Brackets ("L" or "U" shape)
-  > Pivot Delrin

### OVERVIEW

Thank you for purchasing your G5 haptic system! Please make sure to follow each step one by one to make your system operational.

- Unboxing
- Inventory
- Voltage Selection
- Haptic Actuator Endings
- Brackets Installation
- System Connection
- D-BOX Connect Account Creation
- D-BOX HaptiSync Center Installation
- System Configuration
- Test & Play

Complete G5 User Guide is available on our [website](#).

#### 1 | UNBOXING

- 1 Unpack the product from the box.
- 2 Visually inspect the product for damage.
- 3 If any part appears to be broken, contact the D-BOX Support Team\*.

#### 2 | INVENTORY

Ensure that you have all the components necessary to assemble your system. Refer to the "Package Contents" section if needed.

#### 3 | VOLTAGE SELECTION

Set all haptic actuators to meet your region power voltage by using the switch selector located underneath the casing:



#### 4 | HAPTIC ACTUATOR ENDINGS

##### NON-CAPTIVE ENDINGS

G5 haptic actuators come native with non-captive endings. Once the actuators are installed on your platform, simply drop the actuators into the provided metal cups:



# D-BOX G5

## Quick Start Guide

### 4 | HAPTIC ACTUATOR ENDINGS (CONTINUED)

#### CAPTIVE ENDINGS (optional)

Please refer to the G5 User Guide for detailed instructions. **Never operate the haptic actuator(s) without the ending installed. This may lead to irreparable damages to the actuator:**



### 5 | BRACKETS INSTALLATION

Attach your haptic actuators to your platform using either the brackets provided by D-BOX or your reseller. "U" brackets should be mounted first on your platform:

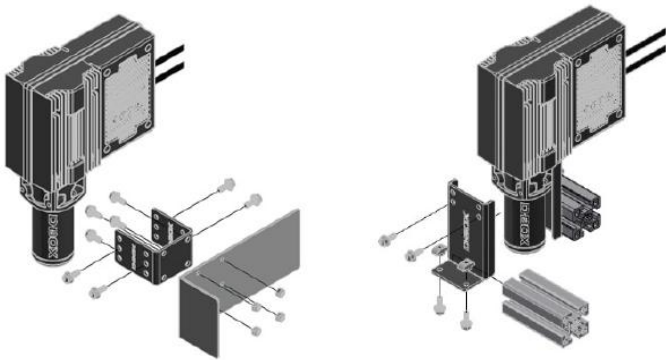

Reseller brackets could be attached in a different way depending on the model. Please refer to the reseller instructions.

### 6 | SYSTEM CONNECTION

1 Connect each actuator RJ45 cable to the Haptic Bridge port lettered as per the plan below. See [G5 User Guide](#) for detailed wiring diagrams.

#### HAPTIC BRIDGE

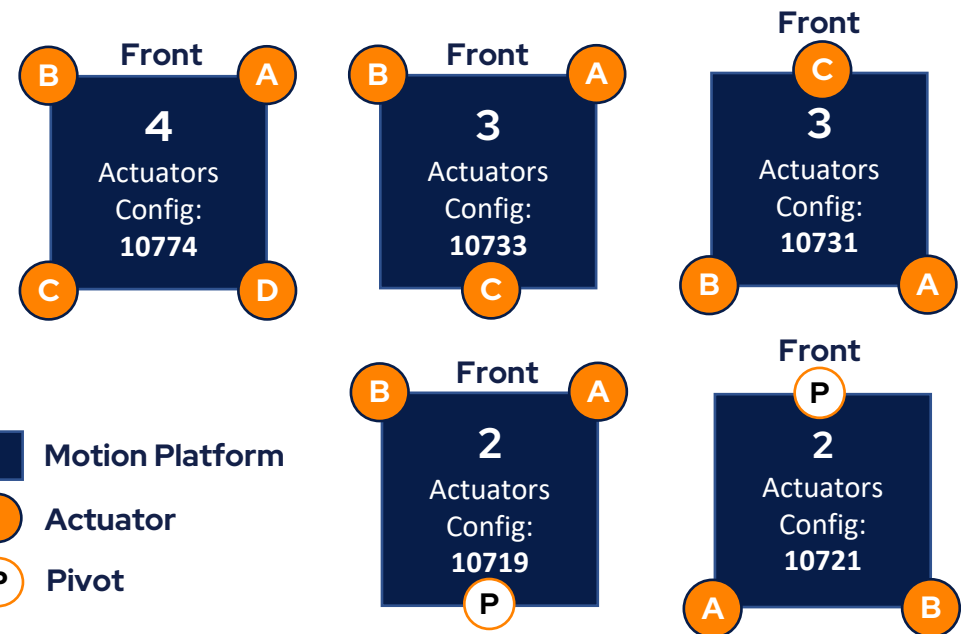
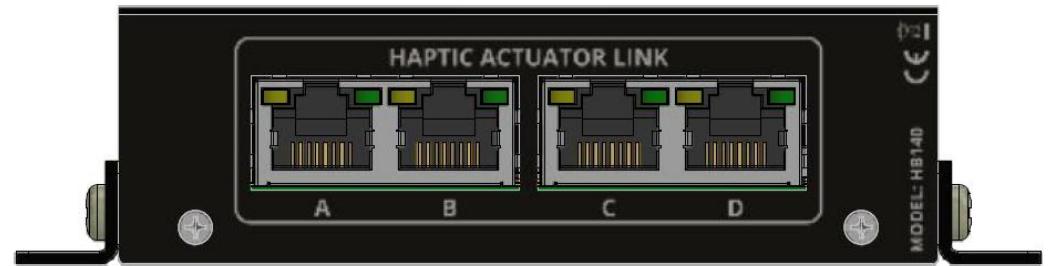

**Configuration number to be entered in the D-BOX System Configurator at Step 9**

# D-BOX G5

## Quick Start Guide

### 6 | SYSTEM CONNECTION (CONTINUED)

- 2 Connect the Haptic Bridge to your PC using the USB cable provided with your haptic system. Connect the power supply to the Haptic Bridge as well as to a power outlet:

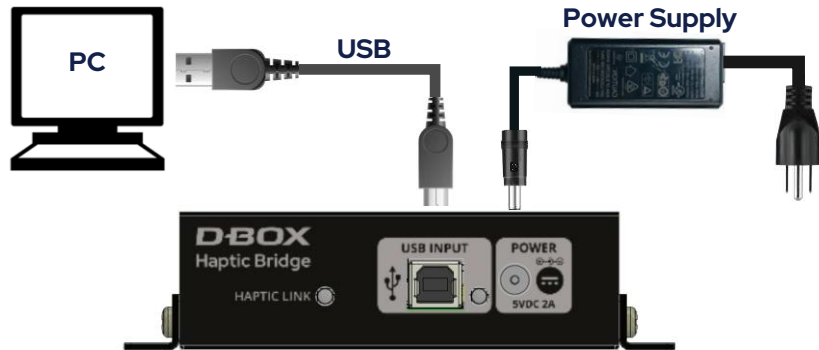

**Do not connect your Haptic Bridge to a USB hub.**

- 3 Connect all actuator power cables to a power outlet. Use the "Y" splitter(s) to simplify the connection.

Install an IEC Plug-Lock insert to each IEC female connector and make sure that all power cables are firmly inserted:



### 7 | D-BOX CONNECT ACCOUNT CREATION

Create your D-BOX account on the D-BOX Connect [website](#).

This is mandatory to install haptic codes for games (D-BOX Coded Gaming mode) and to have access to D-BOX Coded Video mode.

You will be prompted later to log in when opening D-BOX HaptiSync Center.

### 8 | D-BOX HAPTISYNC CENTER INSTALLATION

- 1 Download D-BOX HaptiSync Center from our [website](#).

- 2 Install the software on the computer (PC) that will be connected to your haptic system.

D-BOX HaptiSync software suite includes system's drivers in addition to the following software and utilities:

- D-BOX Adaptive Gaming Configurator
- D-BOX System Monitor
- D-BOX Stimuli Presenter

**Take note that this software cannot be used until you complete your system configuration at step 9.**

# D-BOX G5

## Quick Start Guide

### 9 | SYSTEM CONFIGURATION

Your Haptic Bridge comes with a blank configuration. You need to configure your Haptic Bridge to match your haptic system configuration using the D-BOX System Configurator.

- 1 Download D-BOX System Configurator from our [website](#).
- 2 Extract the compressed file and run the installer. Note that the User Guide is located in the Windows Start menu/D-BOX folder.
- 3 **Firmware update:**
  - a) Make sure your haptic system is powered on.
  - b) Open the D-BOX System Configurator from the Windows Start menu/D-BOX folder.
  - c) From the **Firmware Update** tab, click **Refresh Firmware Status**.
  - d) If the system shows "Outdated (Update firmware)", click **Update Firmware** and follow the on-screen instructions:

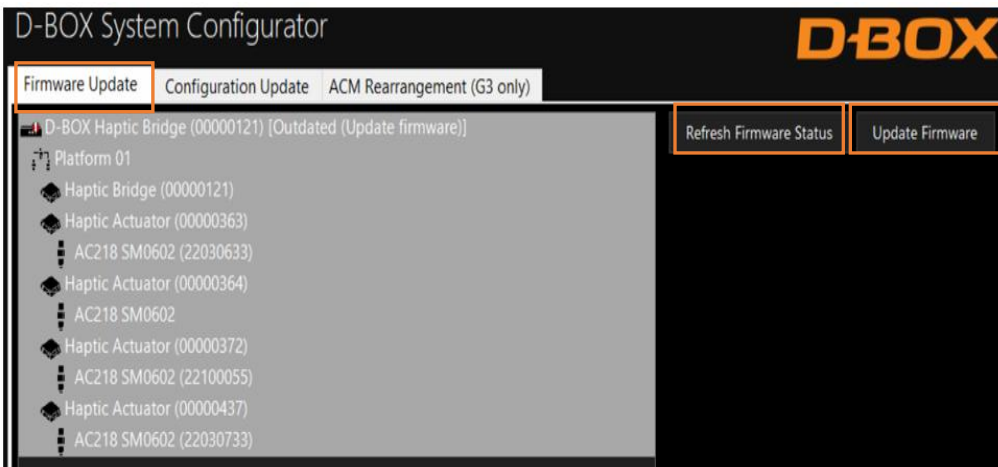

### 4 Configuration update:

- a) Select the **Configuration Update** tab. Click **Refresh Information**.  
Make sure the **Actuator Count** matches with your system. If not, make sure that all power cables and RJ45 are firmly connected.
- b) Enter the configuration number matching your system (**see section 6**) or select the axes you want for your system. Click **Apply Configuration**:

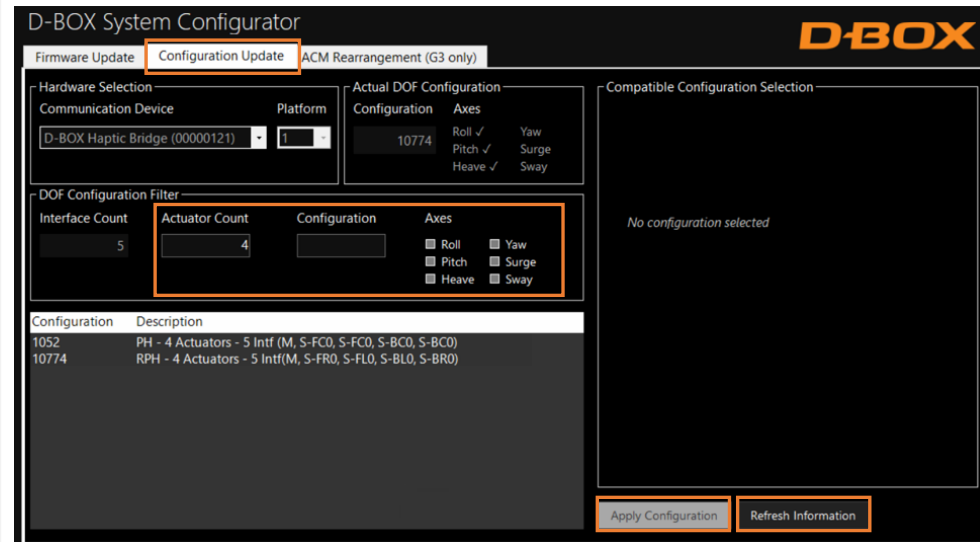

Close the System Configurator when completed.

# D-BOX G5

## Quick Start Guide

### 10 | TEST & PLAY

- 1 From the Windows Start menu, open D-BOX HaptiSync Center and enter your D-BOX Connect account credentials.
- 2 Make sure your HaptiSync Mode is set to **D-BOX Coded Gaming**.
- 3 Click on the **Haptic Output** tab, then click **Start Haptic System Test**.

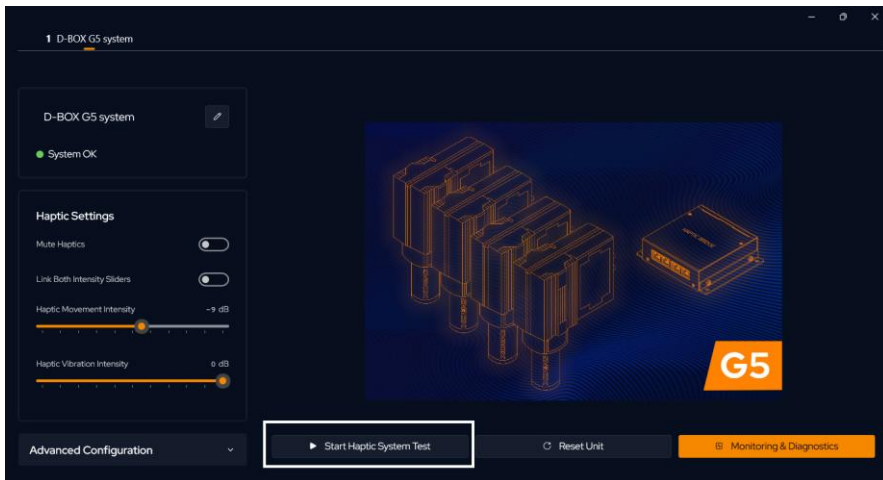

Your haptic system should start moving and vibrate following a factory haptic pattern.

- 4 Click **Stop Haptic System Test** to stop the test.

- 2 It's now the time to enjoy your new haptic system with your favorite game or movie!

In the **HaptiSync Mode** tab, select the HaptiSync mode:

- **D-BOX Coded Gaming:** Premium haptic experiences for D-BOX coded apps, simulators & games. Use the **Adaptive Gaming** mode if your title is not in the list. Click [here](#) for more details.
- **D-BOX Coded Video:** Premium haptic experiences for D-BOX coded movies, TV shows, using audio synchronization. Click [here](#) for more details.
- **Adaptive Gaming:** Haptic experiences using real-time events from game controller or keyboard. Click [here](#) for detailed instructions on how to use this feature.
- **Adaptive Audio:** Automated haptic experiences for any movie, music, TV show and games using audio processing. Click [here](#) for more details.